

RG..D..N



RG 1-phase solid state relays with a communications interface

Communication interface for real time monitoring only



Benefits

- **Communications interface.** Solid state relay parameters and diagnostic data are accessible in real time.
- **Reduced maintenance costs and downtime.** Use of real-time data for prevention of machine stoppages during operation.
- **Good quality products and low scrap rates.** Real-time monitoring allows timely decisions for better machine and process management.
- **Reduced efforts in troubleshooting.** Distinguished faults to facilitate and reduce troubleshooting time.
- **Versatile.** Easy integration in existing machines as the control of the solid state relay does not change compared to a solid state relay without a communication interface.
- **Fast installation and set-up.** The solid state relays on the BUS are addressed by Auto- addressing for fast set-up and prevention of incorrect settings.
- **Compact dimensions.** Slimline RG series for a minimum product width of 17.8 mm, 1x DIN, up to 37 AAC at 40°C.

Description

The **RG..N** solid state relays are the switching components in the NRG BUS chain.

Switching of the **RG..D..N** is controlled by a voltage in the range of 4-32 VDC applied to the specific **RG..D..N**. In addition to the typical switching function of a solid state relay, the **RG..N** has integrated monitoring and a communication interface to provide data of the monitored variables and diagnostic information in real-time. The variables that can be read out from each **RG..D..N** are current, voltage, frequency, power, energy consumption and running hours. The status of each **RG..N** is accessible and in case of an unhealthy status, the specific fault is indicated to facilitate troubleshooting.

The **RG..N** cannot interface directly with the system controller (PLC) but needs to be addressed in an **NRG BUS chain** (as explained further on). 1 **NRG BUS chain** can handle up to 48 **RG..D..Ns**. The first **RG..N** in the BUS chain is connected to the NRG controller, whilst the last **RG..N** in the BUS chain has to be terminated with a BUS terminator provided with the NRG controller.

The **RGC..N** has an integrated heatsink and output ratings go up to 660 VAC, 65 A. The **RGS..N** does not have an integrated heatsink. Maximum output ratings of the **RGS..N** go up to 660 VAC, 90 A. LEDs on the front facade give a visual indication of the status of the **RG..N** output, any ongoing communication and the alarm status of the **RG..N** and its respective load.

Specifications are noted at 25°C unless otherwise specified.

Applications

Any heating application where reliable and precise maintenance of temperatures is crucial to the quality of the end product. Typical applications include plastic machinery such as injection machines, extrusion machines and PET blow moulding machines, packaging machinery, sterilisation machinery, drying tunnels and semiconductor manufacturing equipment.

Main function

- 1-phase AC zero cross solid state relays up to 660 VAC, 90 AAC
- 4-32 VDC control for switching of the solid state relay
- Communications interface for real-time monitoring



The NRG system

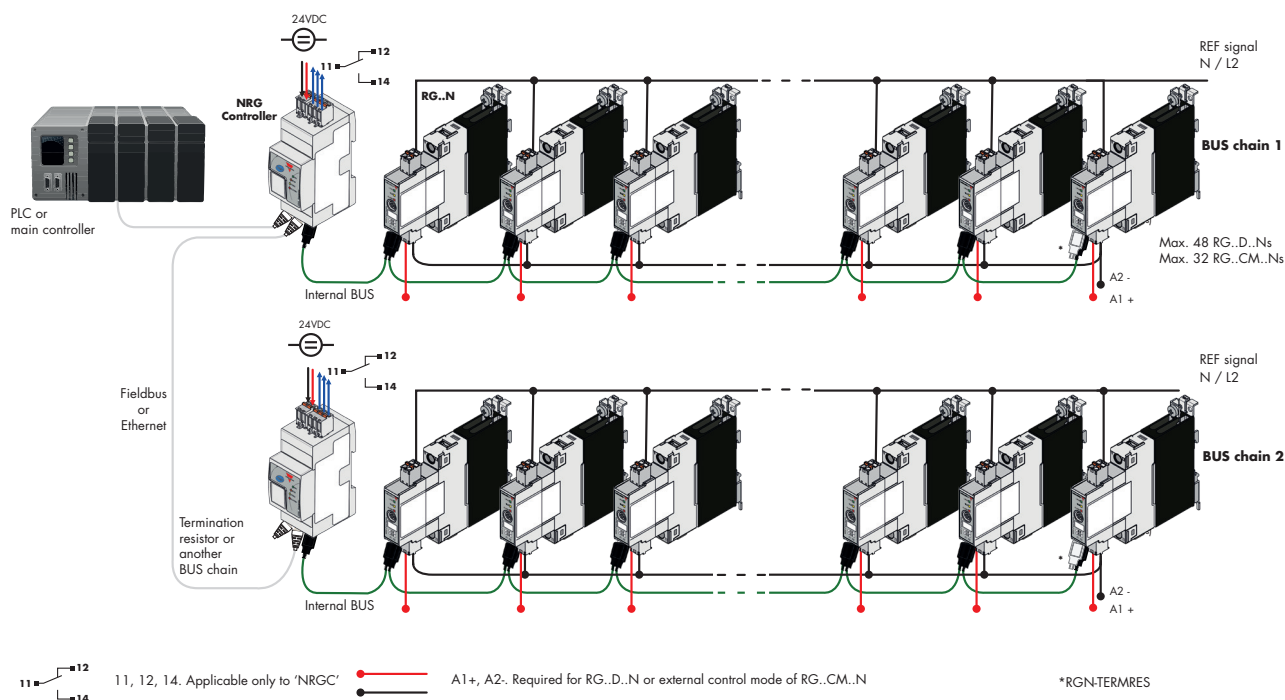

System Overview

The NRG is a system consisting of one or more BUS chains that enable communication between the field devices (such as the solid state relays) and the control devices (such as the machine controller or PLC).

Each **NRG BUS** chain consists of the following 3 components:

- the NRG controller
- the NRG solid state relay(s)
- the NRG internal BUS cables

The **NRG controller** is the interface to the machine controller. It acts as a gateway for the communication between the PLC and the RG..N solid state relays. It is not possible to operate the NRG system without the NRG controller.

The NRG controllers available are:

• NRGC

The NRGC is an NRG controller with a Modbus RTU interface over RS485. The NRGC is addressed via the assigned Modbus ID (from 1-247). In an NRG system operating on Modbus it is possible to have 247 NRG BUS chains.

• NRGC-PN

NRGC-PN is an NRG controller with a PROFINET communication interface. The NRGC-PN is identified by a unique MAC address which is printed on the facade of the product. The GSD file can be downloaded from www.gavazziautomation.com

• NRGC-EIP

NRGC-EIP is an NRG controller with an EtherNet/IP communication interface. The IP address is provided automatically via a DHCP server. The EDS file can be downloaded from www.gavazziautomation.com

▶ NRG system required components

Description	Component code	Notes
Solid state relays	RG..N	NRG solid state relays
NRG controller	NRGC	<ul style="list-style-type: none"> • NRGC: NRG controller with Modbus RTU communication. • NRGC-PN: NRG controller with PROFINET communication. • NRGC-EIP: NRG controller with EtherNet/IP communication. 1x RGN-TERMRES is included in the NRGC.. packaging. The RGN-TERMRES is to be mounted on the last RG..N on the bus chain.
NRG internal BUS cables	RCRGN-xxx	Proprietary cables terminated at both ends with a micro USB connector

▶ List of contents

RG..D..N

References	4
Structure	6
General data	7
RGS output specifications	7
RGC output specifications	8
Input specifications	8
Internal bus	9
Output power dissipation	9
RGS heatsink selection	10
RGS thermal data	10
RGC current derating	11
RGC derating vs. spacing	11
Compatibility and conformance	13
Filter connection diagram	14
Filtering	14
Environmental specifications	15
Measurements	16
LED indicators	16
Alarm management	17
Short circuit protection	18
Dimensions	20
Connection diagrams	23
Functional diagram	24
Mounting	25
Installation	26
Connection specifications	27
RCRGN	29

References

Order code

 RG 1A60D EN

Enter the code entering the corresponding option instead of

Code	Option	Description	Notes
R	-	Solid State Relay (RG)	
G	-		
<input type="checkbox"/>	C	Version with integrated heatsink	
	S	Version without heatsink	
1	-	Number of poles	
A	-	Switching mode: zero cross	
60	-	Rated voltage: 600 VAC (42-660 VAC) 50/60 Hz	
D	-	Control voltage: 4-32 VDC	
<input type="checkbox"/>	25	Rated current - 25 AAC	For RGC..only
	32	Rated current - 30 AAC, 37 AAC	For RGC..only
	42	Rated current - 43 AAC	For RGC..only
	62	Rated current - 65 AAC	For RGC..only
	50	Rated current - 50 AAC	For RGS..only
	92	Rated current - 90 AAC	For RGS..only
<input type="checkbox"/>	K	Screw connection for power terminals	
	G	Box clamp connection for power terminals	
E	-	Connection configuration	
N	-	For integration within an NRG system	

Selection guide - versions with integrated heatsink (RGC)

Rated voltage	Control voltage	Connection power	Rated operational current @ 40°C				
			25 AAC	30 AAC	37 AAC	43 AAC	65 AAC
			Product width				
			17.8 mm	17.8 mm	17.8 mm	35 mm	70 mm
600 VACrms	4 - 32 VDC	Screw	RGC1A60D25KEN	RGC1A60D32KEN	-	-	-
		Box clamp	-	-	RGC1A60D32GEN	RGC1A60D42GEN	RGC1A60D62GEN



Selection guide - versions without heatsink (RGS)

Rated voltage	Control voltage	Connection power	Maximum rated operational current				
			50 AAC	90 AAC	-	-	-
			Product width				
			17.8 mm	17.8 mm		-	-
600 VACrms	4 - 32 VDC	Screw	RGS1A60D50KEN	RGS1A60D92KEN	-	-	-
		Box clamp	-	RGS1A60D92GEN	-	-	-

Carlo Gavazzi compatible components

Description	Component code	Notes
NRG controller	NRGC	NRG controller with Modbus RS485. 1x RGN-TERMRES is included in the NRGC packaging
NRG Internal BUS cables	RCRGN-010-2	10 cm cable terminated at both ends with a microUSB connector. Packed x4 pcs.
	RCRGN-075-2	75 cm cable terminated at both ends with a microUSB connector. Packed x1 pc.
	RCRGN-150-2	150 cm cable terminated at both ends with a microUSB connector. Packed x1 pc.
	RCRGN-350-2	350 cm cable terminated at both ends with a microUSB connector. Packed x1 pc.
	RCRGN-500-2	500 cm cable terminated at both ends with a microUSB connector. Packed x1 pc.
Termination resistor	RGN-TERMRES	Internal BUS chain terminator. 1 pc. is included in the NRGC packaging
Plugs	RGMREF	Spring plug labelled 'Ref'. Packed x10 pcs. 1 pc. included in the RG..N packaging
	RGM25	Spring plug labelled 'A1 A2'. Packed x10 pcs. 1 pc. included in the RG..N packaging
Heatsinks	RHS...	Heatsinks for RGS models

Further reading

Information	Where to find it	
User manual	http://www.gavazziautomation.com/docs/mt_gh/SSR_UM_NRG.pdf	
Datasheet NRG Controller with Modbus RS485 interface	http://www.gavazziautomation.com/docs/mt_gh/SSR_NRGC.pdf	
Online heatsink selector tool for RGS	http://gavazziautomation.com/nsc/HQ/EN/solid_state_relays	

Structure

RG.C..D..N

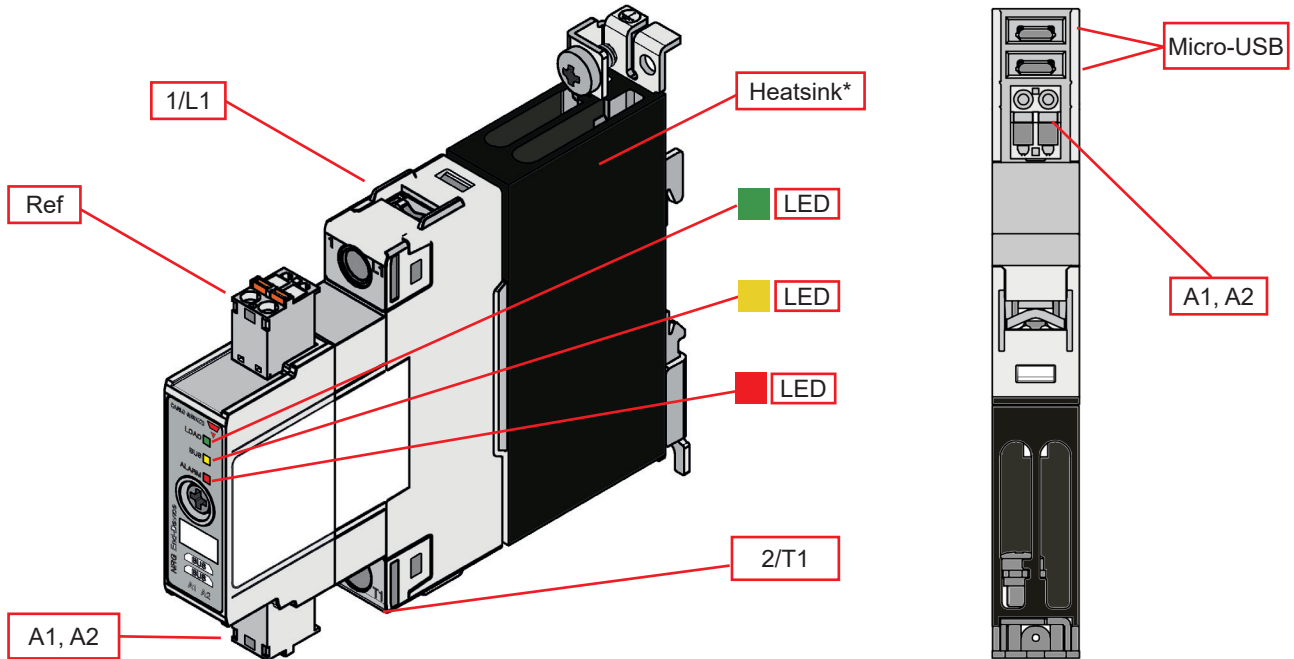

* integrated for RG.C..N versions. RGS..N do not have an integrated heatsink

Element	Component	Function
1/L1	Power connection	Mains connection
2/T1	Power connection	Load connection
Ref	Voltage reference connection	Reference signal (L2 or N) for voltage measurement 2-pole plug internally shorted to allow for looping
A1, A2	Control connection	2-pole plug for control voltage
Green LED	LOAD indicator	Indicates status of RG..N output
Yellow LED	BUS indicator	Indicates ongoing communication
Red LED	ALARM indicator	Indicates presence of an alarm condition
Micro-USB	Micro-USB ports for internal BUS	Interface for RCRGN cable connection for the internal BUS communications line
Heatsink	Integrated heatsink	Integrated for RG.C..N versions RGS..N versions do not have an integrated heatsink

Features

General data

Material	PA66 (UL94 V0), RAL7035 850°C, 750°C/2s according to GWIT and GWF1 requirements of EN 60335-1
Mounting	DIN rail (for RGC only) or panel
Touch Protection	IP20
Overvoltage Category	III, 6 kV (1.2/50 µs) rated impulse withstand voltage
Isolation	Input to Output: 2500 Vrms Input and Output to heatsink: 4000 Vrms
Weight	RGS..50: approx. 170 g RGS..92: approx. 170 g RGC..25: approx. 310 g RGC..32: approx. 310 g RGC..42: approx. 520 g RGC..62: approx. 1030 g
Compatibility	NRGC (NRG controller with Modbus RS485 interface)

Performance

RGS.. Output

	RGS..50..	RGS..92..
Operational voltage range, Ue	42 – 660 VAC	
Switching mode	Zero cross switching	
Max. operational current: AC-51 rating¹	50 AAC	90 AAC
Operational frequency range	50/60 Hz	
Blocking voltage	1200 Vp	
Power factor	> 0.9	
Output overvoltage protection	Integrated varistor across L1-T1	
Leakage current @ rated voltage	< 5 mAAC	
Minimum operational current	300 mAAC	500 mAAC
Maximum transient surge current (I_{TSM}), t=10 ms	600 Ap	1900 Ap
I²t for fusing (t=10 ms), minimum	1800 A ² s	18000 A ² s
LED indication - LOAD	Green, ON when control output is ON	
Critical dV/dt (@T_J init = 40°C)	1000 V/µs	

1. Max. rated current with suitable heatsink. Refer to RGS heatsink selection tables.

▶ RGC.. Output

	RGC..25	RGC..32	RGC..42	RGC..62
Operational voltage range, Ue	42 - 660 VAC			
Switching mode	Zero cross switching			
Max. operational current: AC-51 rating @ 25°C ²	30 AAC	30 AAC KEN 43 AAC GEN	50 AAC	75 AAC
Max. operational current: AC-51 rating @ 40°C ²	25 AAC	30 AAC KEN 37 AAC GEN	43 AAC	65 AAC
Operational frequency range	50/60 Hz			
Blocking voltage	1200 Vp			
Power factor	> 0.9			
Output overvoltage protection	Integrated varistor across L1-T1			
Leakage current @ rated voltage	< 5 mAAC			
Minimum operational current	300 mAAC	500 mAAC	500 mAAC	500 mAAC
Maximum transient surge current (I _{TSM}), t=10 ms	600 Ap	1900 Ap	1900 Ap	1900 Ap
I ² t for fusing (t=10 ms), minimum	1800 A ² s	18000 A ² s	18000 A ² s	18000 A ² s
LED indication - LOAD	Green, ON when output is ON			
Critical dV/dt (@Tj init = 40°C)	1000 V/μs			

2. Refer to RGC current derating curves for current ratings at different surrounding temperatures.

▶ Inputs

Control voltage range, Uc: A1, A2	4-32 VDC
Pick-up voltage	3.8 VDC
Drop-out voltage	1 VDC
Maximum reverse voltage	32 VDC
Maximum response time pick-up	½ cycle
Response time drop-out	½ cycle
Input current @ 40°C	See diagram below

Note: The output of the SSR is independent of the communications interface, therefore, the control voltage switches ON/OFF the output of the SSR even when this is not connected to the BUS chain (i.e., the RCRGN cable is not connected or a problematic BUS communication line).

▶ Input current vs. input voltage

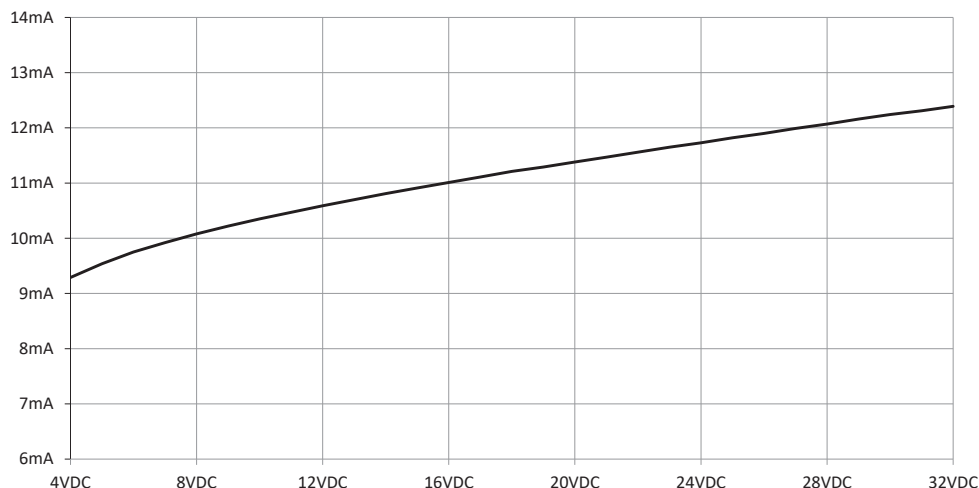

Internal bus

Supply voltage	Supplied through 2 wires of the RCRGN bus cable when connected to a powered NRG controller
BUS termination	RGN-TERMRES on last device in the bus chain
Max. no. of RG..Ns in a bus chain	48
LED indication - BUS	Yellow, ON during ongoing communication
ID for RG..Ns	Automatic through Auto- addressing (refer to NRG User Manual for further details) Communication is only possible with RG..Ns that are addressed correctly, i.e., they have a valid ID.

Output power dissipation

RGS..

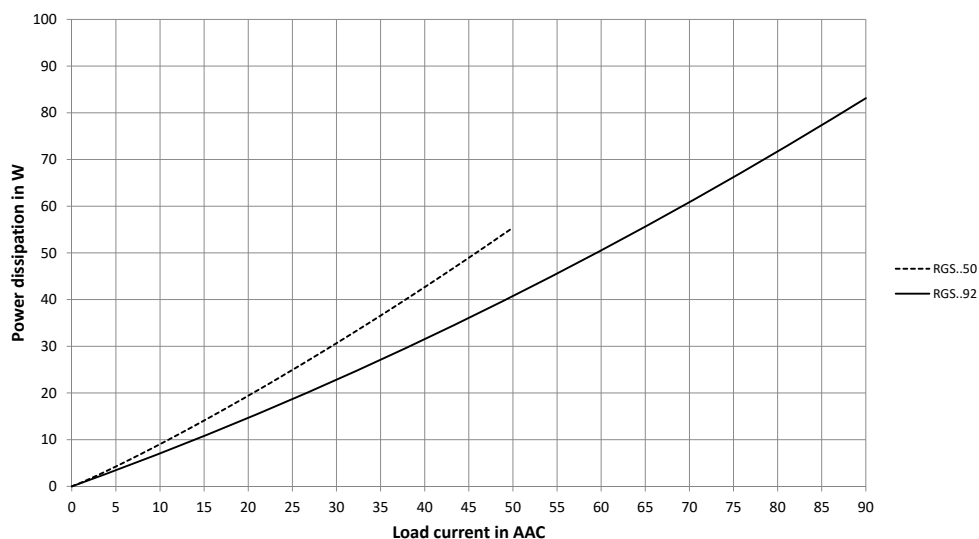

RGC..

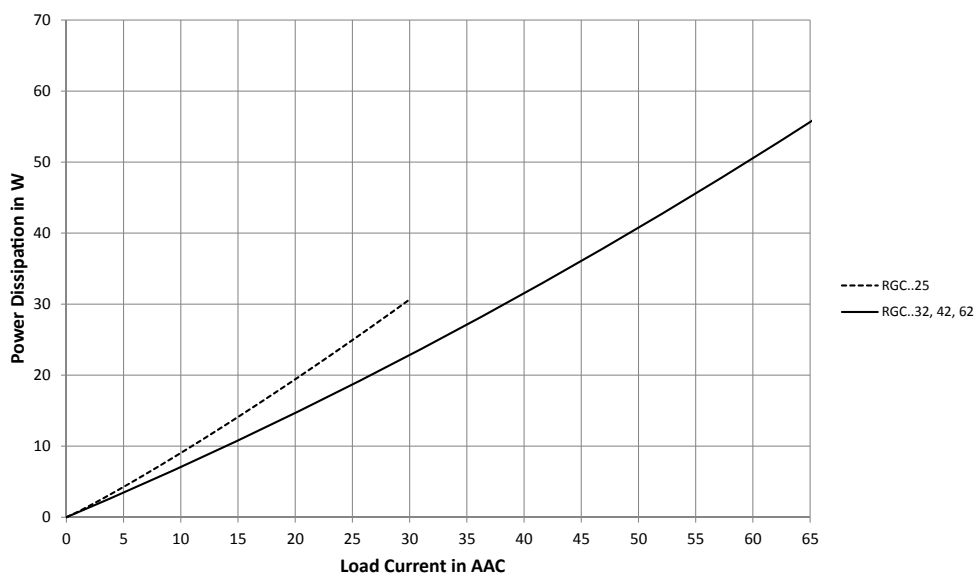

RGS.. Heatsink selection

Thermal resistance [°C/W] of RGS..50

Load current per pole AC-51 [A]	Surrounding ambient temperature [°C]					
	20	30	40	50	60	65
50	1.45	1.28	1.06	0.87	0.68	0.59
45	1.72	1.50	1.29	1.07	0.85	0.75
40	2.00	1.75	1.50	1.25	1.00	0.87
35	2.35	2.06	1.76	1.47	1.18	1.03
30	2.83	2.48	2.13	1.77	1.42	1.24
25	3.52	3.08	2.64	2.20	1.76	1.54
20	4.58	4.01	3.44	2.86	2.29	2.01
15	6.40	5.60	4.80	4.00	3.20	2.80
10	10.19	8.92	7.64	6.37	5.10	4.46
5	--	19.51	16.72	13.94	11.15	9.76

Thermal resistance [°C/W] of RGS..92

Load current per pole AC-51 [A]	Surrounding ambient temperature [°C]					
	20	30	40	50	60	65
90	0.62	0.52	0.41	0.31	0.21	0.16
81	0.77	0.66	0.54	0.42	0.31	0.25
72	0.97	0.83	0.70	0.56	0.43	0.36
63	1.23	1.07	0.91	0.75	0.59	0.51
54	1.55	1.35	1.16	0.97	0.77	0.68
45	1.93	1.69	1.45	1.21	0.97	0.85
36	2.53	2.21	1.89	1.58	1.26	1.11
27	3.55	3.11	2.66	2.22	1.77	1.55
18	5.67	4.97	4.26	3.55	2.84	2.48
9	12.46	10.90	9.34	7.79	6.23	5.45

RGS.. Thermal data

	RGS..50	RGS..92
Max. junction temperature	125°C	
Heatsink temperature	100°C	
Junction to case thermal resistance, R_{thjc}	< 0.30°C/W	< 0.20°C/W
Case to heatsink thermal resistance, R_{thcs}	< 0.25°C/W	

RG.. Current derating

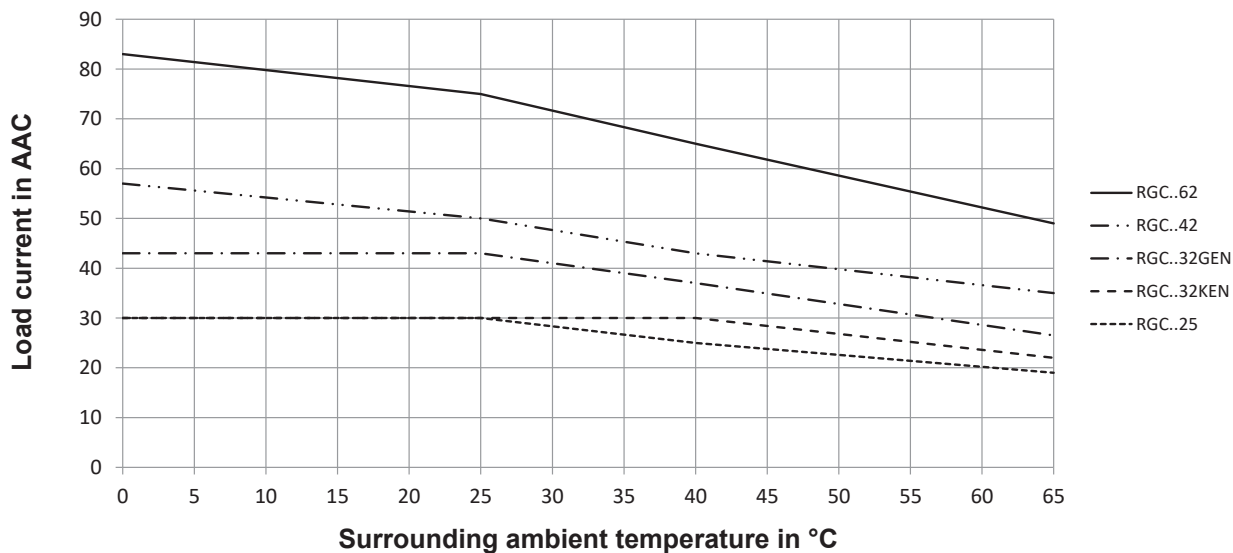

RG.. Derating vs spacing

RG...25

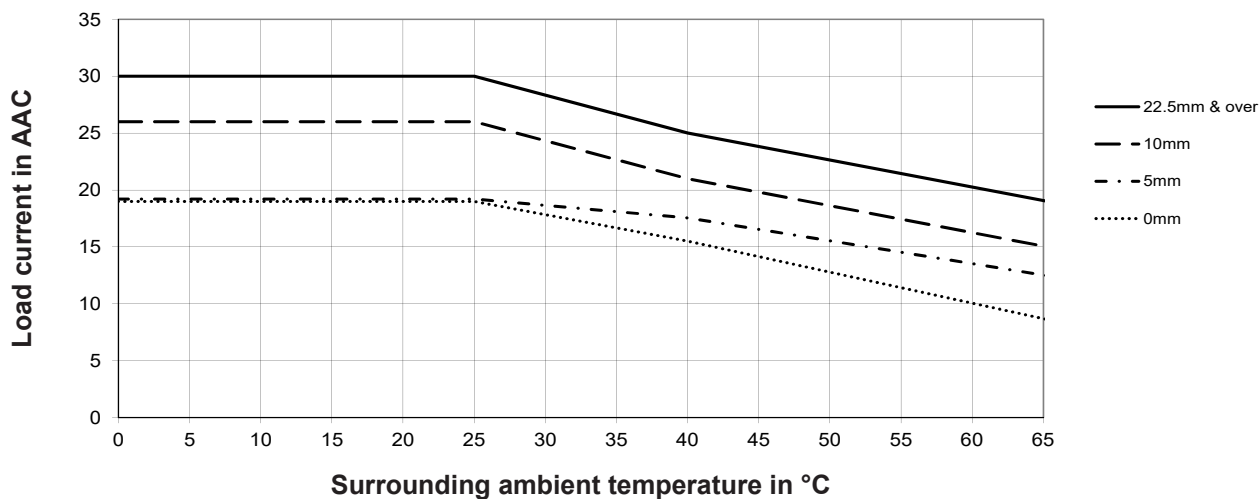



RGC...32

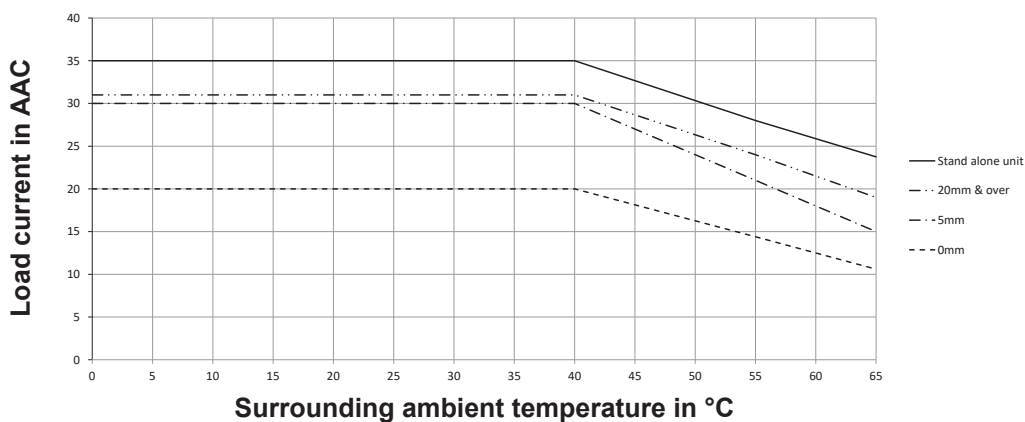



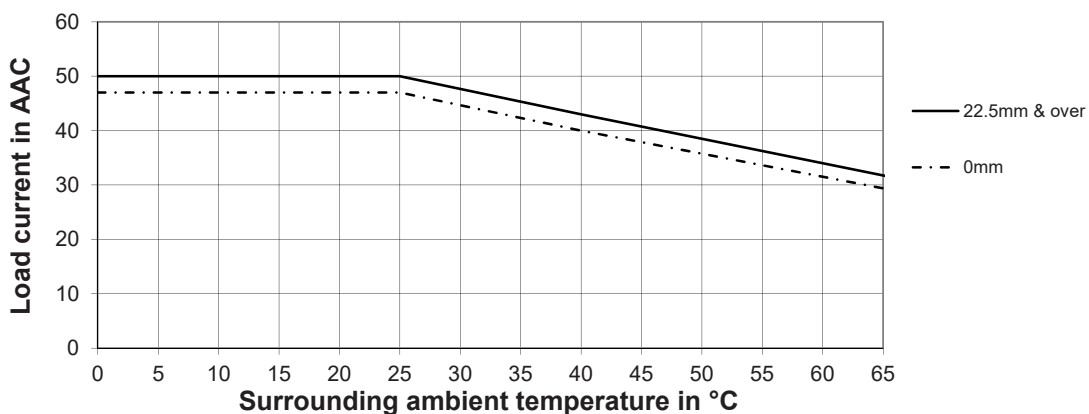

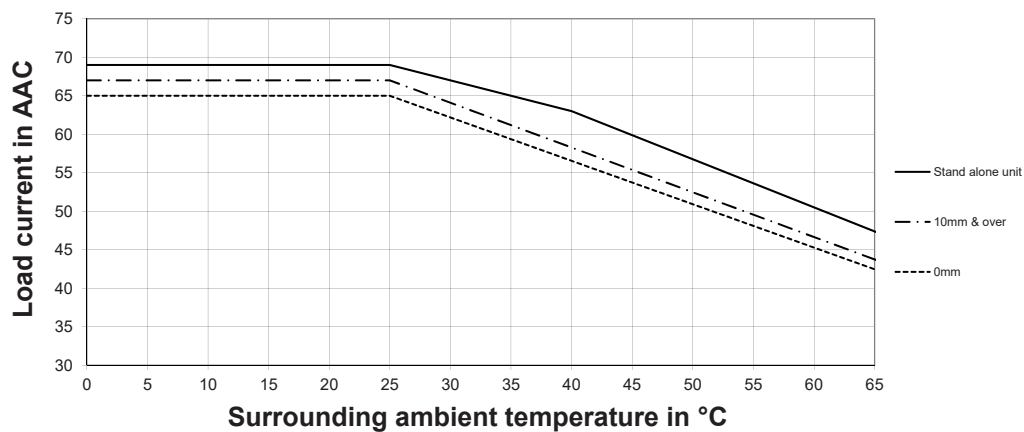

RGC...42



RGC...62



Compatibility and conformance

Approvals	RGC:   
	RGS:   
Standards compliance	LVD: EN 60947-4-3 EMCD: EN 60947-4-3 UL: UL508, E172877, NMFT cUL: C22.2 No. 14-13, E172877, NMFT7 UR: UL508, E172877, NMFT2 (for RGS..N) cUR: C22.2 No. 14-13, E172877, NMFT8 (for RGS..N) CSA: C22.2 No. 14-13, 204075 (for RGS..N)
UL short circuit current rating	100 k Arms (refer to short circuit current section, Type 1 – UL508)

Electromagnetic compatibility (EMC) - Immunity	
Electrostatic discharge (ESD)	EN/IEC 61000-4-2 8 kV air discharge, 4 kV contact (PC1)
Radiated radio frequency³	EN/IEC 61000-4-3 10 V/m, from 80 MHz to 1 GHz (PC1) 10 V/m, from 1.4 to 2 GHz (PC1) 3 V/m, from 2 to 2.7 GHz (PC1)
Electrical fast transient (burst)	EN/IEC 61000-4-4 Output: 2 kV, 5 kHz & 100 kHz (PC1) Input, BUS: 1 kV, 5 kHz & 100 kHz (PC1)
Conducted radio frequency³	EN/IEC 61000-4-6 10 V/m, from 0.15 to 80 MHz (PC1)
Electrical surge	EN/IEC 61000-4-5 Output, line to line: 1 kV (PC2) Output, line to earth: 2 kV (PC2) BUS (Supply), line to line: 500 V (PC2) BUS (Supply), line to earth: 500 V (PC2) BUS (Data), A1-A2, line to earth: 1 kV (PC2) ⁴
Voltage dips	EN/IEC 61000-4-11 0% for 0.5, 1 cycle (PC2) 40% for 10 cycles (PC2) 70% for 25 cycles (PC2) 80% for 250 cycles (PC2)
Voltage interruptions	EN/IEC 61000-4-11 0% for 5000 ms (PC2)

3. Under the influence of RF, a reading error of $\pm 10\%$ was allowed for load currents > 500 mA and $\pm 20\%$ for load currents < 500 mA. These tolerances are not maintained if Ref signal is not connected.

4. Not applicable to shielded cables < 10 m. Additional suppression on data lines may be required if shielded cables are not used.

Electromagnetic compatibility (EMC) - Emissions	
Radio interference field emission (radiated)	EN/IEC 55011 Class A: from 30 to 1000 MHz
Radio interference voltage emissions (conducted)	EN/IEC 55011 Class A: from 0.15 to 30 MHz (External filter may be required - refer to Filtering section)

Environmental specifications

Operating temperature	-20 to +65 °C (-4 to +149 °F)
Storage temperature	-20 to +65 °C (-4 to +149 °F)
Relative humidity	95% non-condensing @ 40°C
Pollution degree	2
Installation altitude	0-1000 m. Above 1000 m derate linearly by 1% of FLC per 100 m up to a maximum of 2000 m
Vibration resistance	2 g / axis (2-100Hz, IEC60068-2-6, EN 50155)
Impact resistance	15/11 g/ms (EN 50155)
EU RoHS compliant	Yes
China RoHS	

The declaration in this section is prepared in compliance with People's Republic of China Electronic Industry Standard SJ/T11364-2014: Marking for the Restricted Use of Hazardous Substances in Electronic and Electrical Products.

Part Name	Toxic or Harardous Substances and Elements					
	Lead (Pb)	Mercury (Hg)	Cadmium (Cd)	Hexavalent Chromium (Cr(VI))	Polybrominated biphenyls (PBB)	Polybrominated diphenyl ethers (PBDE)
Power Unit Assembly	x	0	0	0	0	0

O: Indicates that said hazardous substance contained in homogeneous materials for this part are below the limit requirement of GB/T 26572.

X: Indicates that said hazardous substance contained in one of the homogeneous materials used for this part is above the limit requirement of GB/T 26572.

这份申明根据中华人民共和国电子工业标准 SJ/T11364-2014：标注在电子电气产品中限定使用的有害物质

零件名称	有毒或有害物质与元素					
	铅 (Pb)	汞 (Hg)	镉 (Cd)	六价铬 (Cr(VI))	多溴化联苯 (PBB)	多溴联苯醚 (PBDE)
功率单元	x	0	0	0	0	0

O:此零件所有材料中含有的该有害物低于GB/T 26572的限定。

X: 此零件某种材料中含有的该有害物高于GB/T 26572的限定。



Measurements

Parameter	Register reference	Description
Current	CRRDR	This reports the measured load RMS current.
Hold current	CUHDR	This reports the highest RMS value of current recorded over a number of (past) cycles. The number of past cycles is addressable.
Voltage	VRRDR	RMS voltage reading (L1-Ref voltage) that is the supply voltage across the SSR + load (Ref signal connection is required)
Frequency	FQRDR	This reports the measured line frequency.
Apparent power	APRDR	This reports the apparent power that is a multiplication of the voltage RMS value and current RMS value. (Ref signal connection is required)
Real power	RPRDR	This reports the real power reading that is based on the instantaneous voltage & current multiplications. (Ref signal connection is required)
Running hours (On-time)	OTRDR	This is a count of the time during which the SSR output is ON. On switch ON, this register reports the recorded value at the last switch OFF.
Active Energy	ENRDLR, ENRDHR	This reports the energy reading in kWh. On switch ON, this register reports the recorded value at the last switch OFF. (Ref signal connection is required)

Note 1: For further information please refer to the 'NRG user manual'.

Note 2: Ref signal connection is recommended with loads less than 1A

LED indicators

LOAD	Green 	The Load LED reflects the status of the load depending on the presence of the control signal. During an over-temperature condition, the LOAD LED will behave according to the indications in the table "LOAD LED indications in over-temperature condition" below	
BUS	Yellow 	ON:	During a response from the RG..N to the NRG controller
		OFF:	Communication between the NRG controller and RG..Ns is idle or during the transmission of a command from the NRG controller to the RG..N
ALARM	Red 	ON:	Fully ON or flashing when alarm condition is present. Refer to Alarm Management section
		OFF:	No alarm condition

LOAD LED indications in over-temperature condition

Control signal A1, A2	RG..N supply (through internal bus by RCRGN..)	Over-temperature condition	LOAD LED green 
ON	OFF	Detection not possible without BUS connected	ON
ON	ON	OFF	ON
ON	ON	ON	OFF
OFF	OFF	Detection not possible without BUS connected	OFF
OFF	ON	ON	OFF
OFF	ON	OFF	OFF

Alarm management

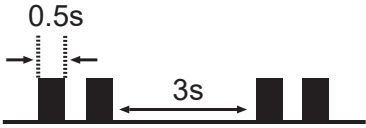
<p>Alarm condition present</p>	<ul style="list-style-type: none"> • The state of the Red LED of the respective RG..N is ON with a specific flashing rate • Alarm flag (AL1SF), Comms error flag (CMERF) or internal error flag (INERF) in the RG..N status register (EDGSR) is set • Any of the flags in the Alarm 1 status register (AL1SR) of the respective RG..N is set <p>Please refer to the NRG User Manual for further information</p>	
<p>Alarm types</p>	<p>No. of flashes</p>	<p>Description of fault</p>
	<p>100% ON</p>	<p>Over-temperature:</p> <ul style="list-style-type: none"> - The RG..N is operating outside its operating range causing the junction to overheat - The output of the RG..N is switched OFF (irrespective of the control voltage presence) to prevent damage to the RG..N - The alarm is restored automatically after the cooling-off period
	<p>2</p>	<p>Mains loss:</p> <p>Voltage and current signals are absent. The cause is a mains loss (with REF terminal connected)</p>
	<p>3</p>	<p>Load loss / SSR open circuit:</p> <p>Load is not switching ON when control signal is present. The cause is either a load loss or a RG..N open circuit condition</p>
	<p>4</p>	<p>SSR short circuit:</p> <p>Current flowing through the RG..N output in the absence of a control signal</p>
	<p>5</p>	<p>Frequency Out of Range:</p> <ul style="list-style-type: none"> - The RG..N is operated outside the range set by the Over Frequency and Under Frequency Limit registers (OFLMR and UFLMR). - Default range is 44 – 66 Hz - The RG..N will not stop operating if the frequency measured is out of the set range. The alarm is restored automatically when the frequency is back within the expected range
	<p>6</p>	<p>Current Out of Range:</p> <ul style="list-style-type: none"> - The RG..N is operated outside the range set by the Over Current and Under Current Limit registers (OCLMR and UCLMR). - Default range is 0 – max. rating of the respective RG..N - The RG..N will not stop operating if the current measured is out of the set range. The alarm is restored automatically when the current is back within the expected range
	<p>7</p>	<p>Voltage Out of Range:</p> <ul style="list-style-type: none"> - The RG..N is operated outside the range set by the Over Voltage and Under Voltage Limit registers (OVLMR and UVLMR). - Default range is 0 – 660 V - The RG..N will not stop operating if the voltage measured is out of the set range. The alarm is restored automatically when the voltage is back within the expected range
	<p>8</p>	<p>Communication error (BUS):</p> <p>An error in the communication link (internal bus) between the NRG and RG..Ns</p>
	<p>9</p>	<p>Internal error:</p> <p>Bus supply out of range, hardware damage or detection of abnormal conditions</p>
<p>Flashing rate</p>	 <p>The diagram shows a series of rectangular pulses. The width of each pulse is labeled as 0.5s. The time interval between the start of one pulse and the start of the next pulse is labeled as 3s.</p>	

Short circuit protection

Protection Co-ordination, Type 1 vs Type 2:

Type 1 protection implies that after a short circuit, the device under test will no longer be in a functioning state. In Type 2 co-ordination the device under test will still be functional after the short circuit. In both cases, however the short circuit has to be interrupted. The fuse between enclosure and supply shall not open. The door or cover of the enclosure shall not be blown open. There shall be no damage to conductors or terminals and the conductors shall not separate from terminals. there shall be no breakage or cracking of insulating bases to the extent that the integrity of the mounting of live parts is impaired. Discharge of parts or any risk of fire shall not occur.

The product variants listed in the table hereunder are suitable for use on a circuit capable of delivering not more than 100,000A rms Symmetrical Amperes, 600 Volts maximum when protected by fuses. Tests at 100,000A were performed with Class J fuses, fast acting; please refer to the table below for maximum allowed ampere rating of the fuse. Use fuses only.

Tests with Class J fuses are representative of Class CC fuses.

Protection co-ordination Type 1 according to UL 508				
Part No.	Prospective short circuit current [kArms]	Max fuse size [A]	Class	Voltage [VAC]
RGS..50, RGC..25	100	30	J or CC	max. 600
RGS..92, RGC..32, RGC..42, RGC..62	100	80	J	max. 600

Protection co-ordination Type 2 with semiconductor fuses						
Part number	Prospective short circuit current [kArms]	Mersen (Ferraz Shawmut)		Siba		Voltage [VAC]
		Max fuse size [A]	Part number	Max fuse size [A]	Part number	
RGC..25	10	40	6.9xx CP GRC 22x58 /40	32	50 142 06.32	max. 600
	100	40	6.9xx CP GRC 22x58 /40	32	50 142 06.32	max. 600
RGC..32 RGC..42	10	63	6.9xx CP URC 14x51 /63	80	50 194 20.80	max. 600
	10	70	A70QS70-4	80	50 194 20.80	max. 600
	100	63	6.9xx CP URC 14x51 /63	80	50 194 20.80	max. 600
	100	70	A70QS70-4	80	50 194 20.80	max. 600
RGC..62	10	100	6.9xx CP GRC 22x58 /100	100	50 194 20.100	max. 600
	10	100	A70QS100-4	100	50 194 20.100	max. 600
	100	100	6.621 CP URGD 27x60 /100	100	50 194 20.100	max. 600
	100	100	A70QS100-4	100	50 194 20.100	max. 600
RGS..50	10	80	6.621 CP URQ 27x60 /80	50	50 142 06.50	max. 660
	10	70	A70QS70-4	50	50 142 06.50	max. 660
	100	80	6.621 CP URQ 27x60 /80	50	50 142 06.50	max. 660
	100	70	A70QS70-4	50	50 142 06.50	max. 660
RGS..92	10	125	6.621 CP URD 22x58 /125	125	50 194 20.125	max. 660
	10	125	A70QS125-4	125	50 194 20.125	max. 660
	100	125	6.621 CP URD 22x58 /125	125	50 194 20.125	max. 660
	100	125	A70QS125-4	125	50 194 20.125	max. 660

Protection co-ordination Type 2 with Minature Circuit Breakers (M.C.B.s)				
Solid State Relay type	ABB Model no. for Z - type M. C. B. (rated current)	ABB Model no. for B - type M. C. B. (rated current)	Wire cross sectional area [mm ²]	Minimum length of Cu wire conductor [m] ⁵
RGS..50, RGC..25 (1800 A ² s)	1-pole S201 - Z10 (10 A)	S201-B4 (4 A)	1.0	7.6
			1.5	11.4
			2.5	19.0
	S201 - Z16 (16 A)	S201-B6 (6 A)	1.0	5.2
			1.5	7.8
			2.5	13.0
			4.0	20.8
	S201 - Z20 (20 A)	S201-B10 (10 A)	1.5	12.6
			2.5	21.0
	S201 - Z25 (25 A)	S201-B13 (13 A)	2.5	25.0
4.0			40.0	
2-pole S202 - Z25 (25 A)	S202-B13 (13 A)	2.5	19.0	
		4.0	30.4	
RGS..92, RGC..32, RGC..42, RGC..62 (18000 A ² s)	1-pole S201 - Z32 (32 A)	S201-B16 (16 A)	2.5	3.0
			4.0	4.8
			6.0	7.2
	S201 - Z50 (50 A)	S201-B25 (25 A)	4.0	4.8
			6.0	7.2
			10.0	12.0
			16.0	19.2
	S201 - Z63 (63 A)	S201-B32 (32 A)	6.0	7.2
			10.0	12.0
			16.0	19.2

5. Between MCB and Load (including return path which goes back to the mains)

Note: A prospective current of 6 kA and a 230 / 400 V power supply is assumed for the above suggested specifications. For cables with different cross section than those mentioned above please consult Carlo Gavazzi's Technical Support Group.

Dimensions

RGS...KEN

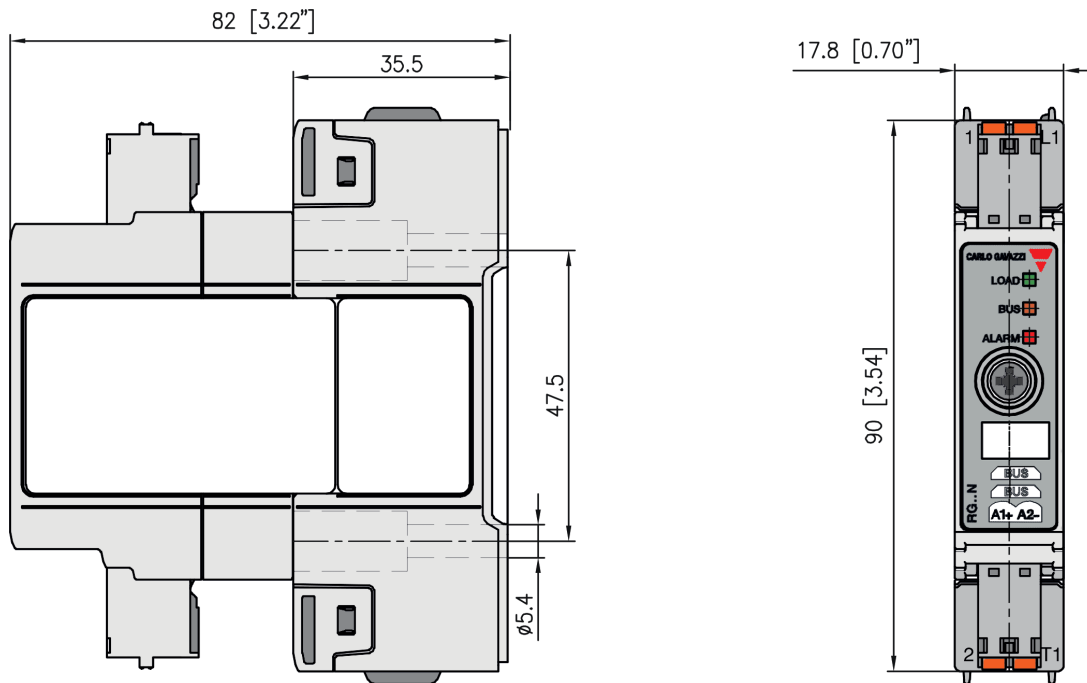

RGS...GEN

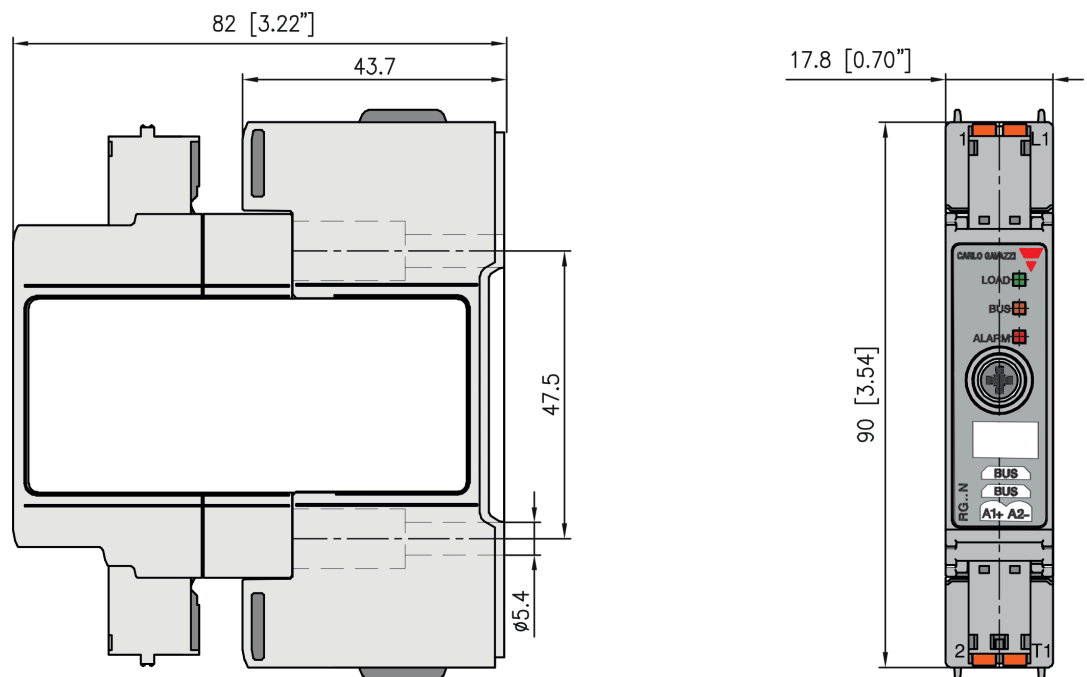

Housing width tolerance +0.5mm, -0mm as per DIN 43880.
 All other tolerances +/- 0.5mm.
 Dimensions in mm.

RGC...25KEN, RGC...32KEN

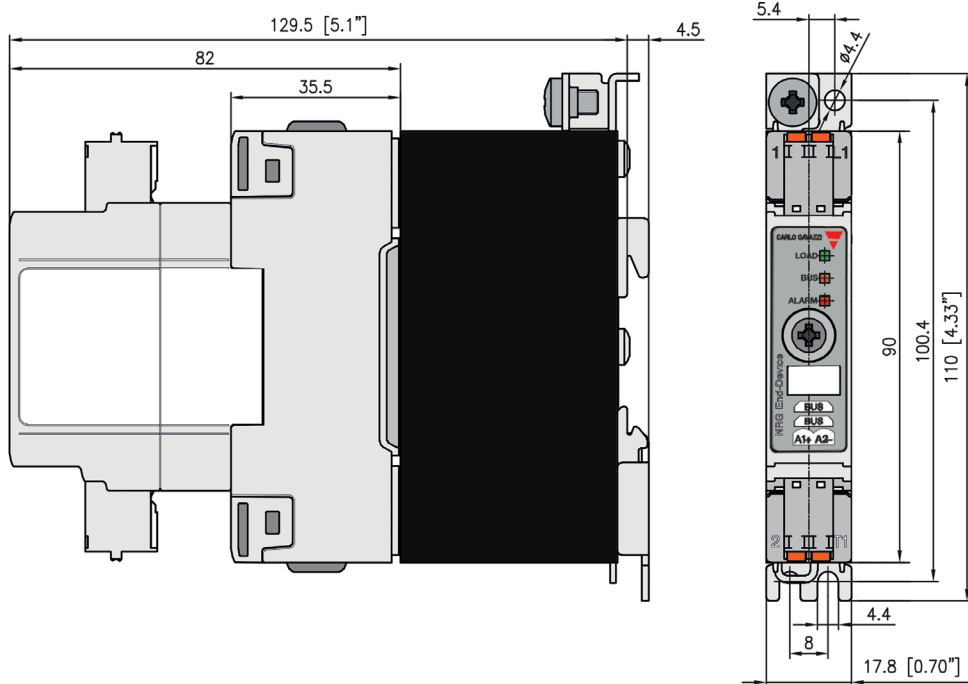

RGC...32GEN

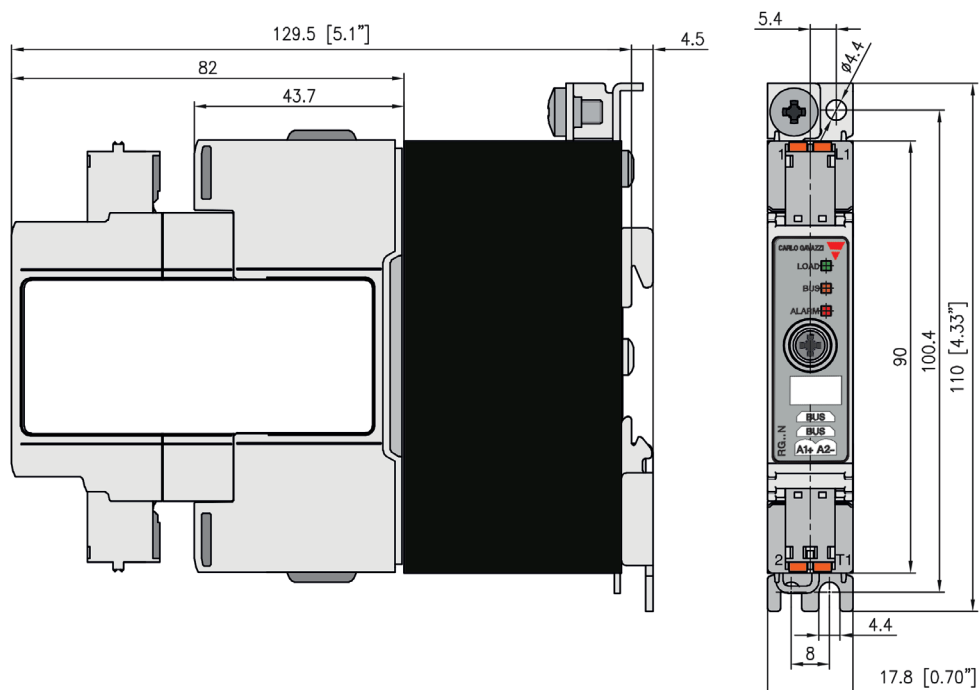

Housing width tolerance +0.5mm, -0mm as per DIN 43880.
 All other tolerances +/- 0.5mm.
 Dimensions in mm.

RGC...42GEN

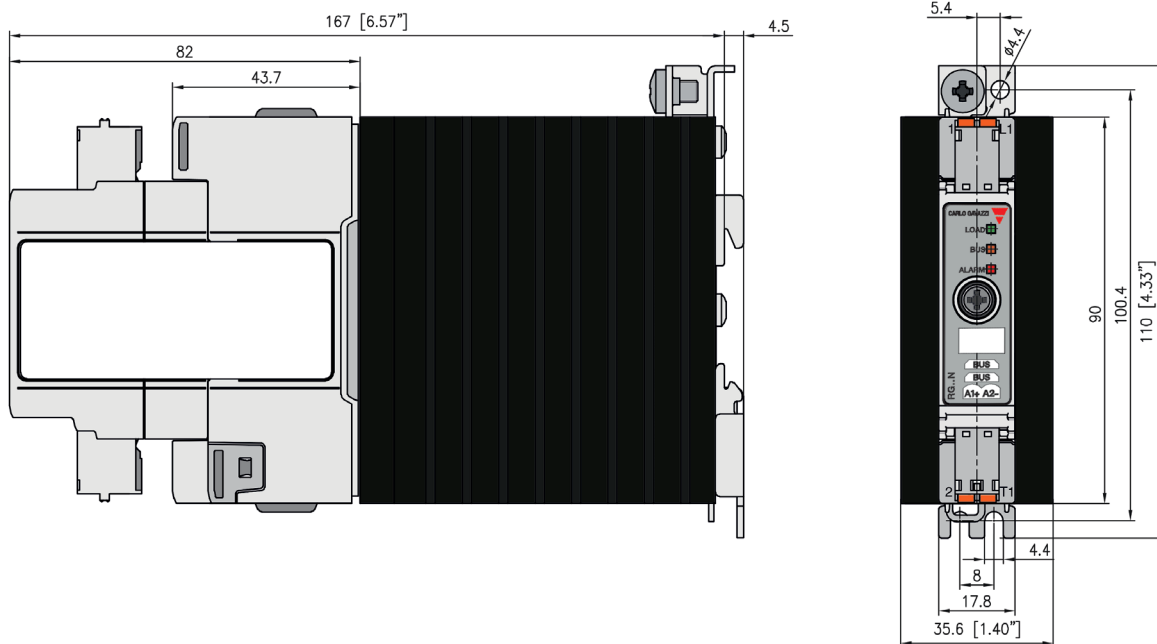

RGC...62GEN

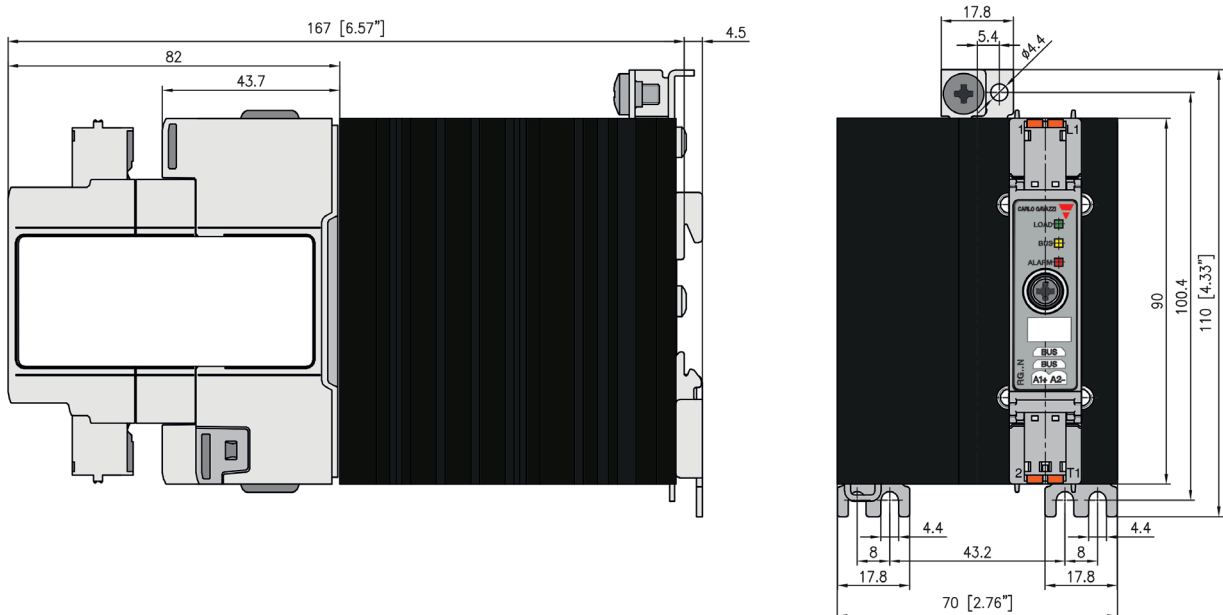

Housing width tolerance +0.5mm, -0mm as per DIN 43880.
 All other tolerances +/- 0.5mm.
 Dimensions in mm.

▶ Load connection diagram

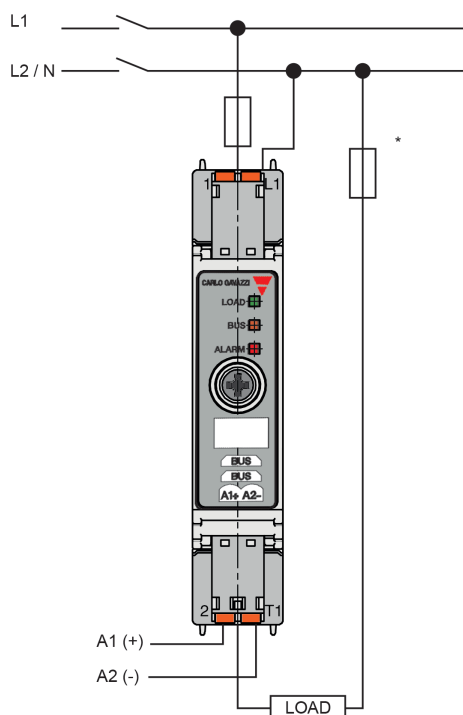

*depends on system requirements

BUS connection diagram

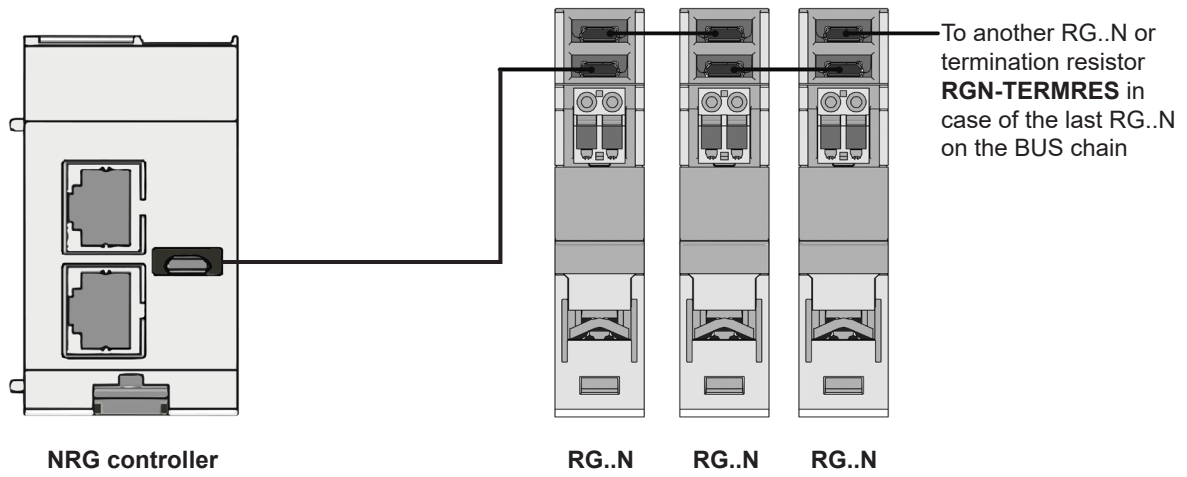

Functional diagram

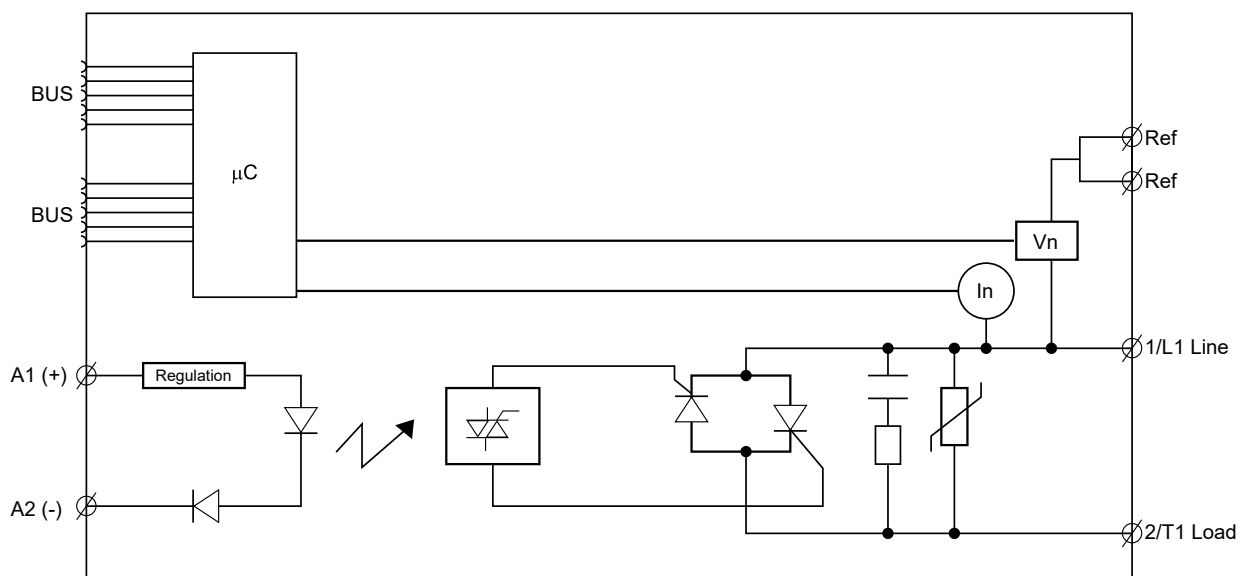

Mounting

RGC

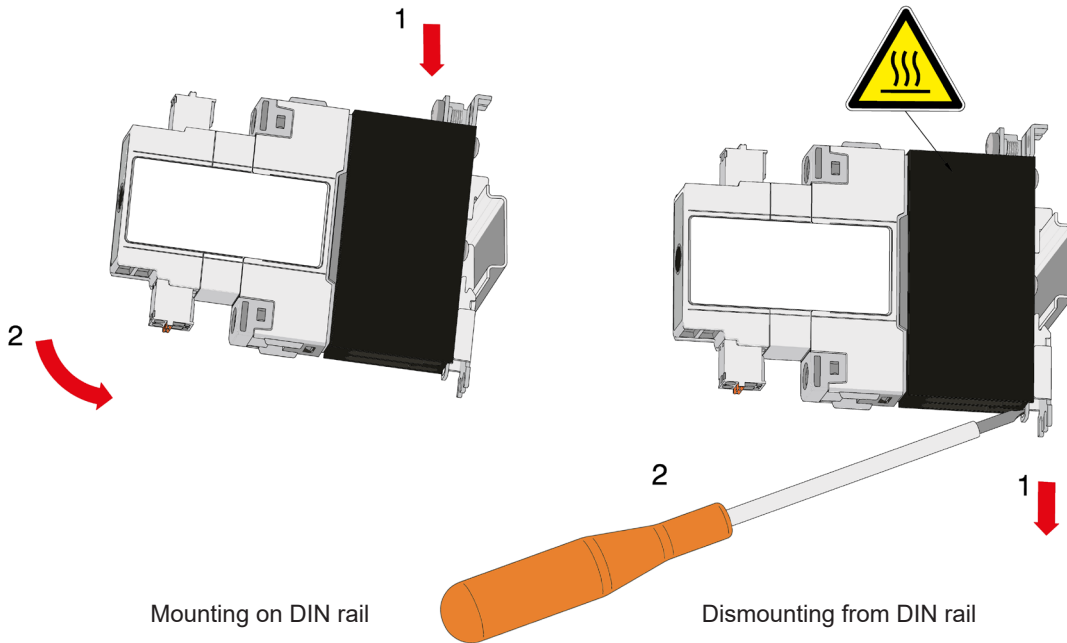

RGS

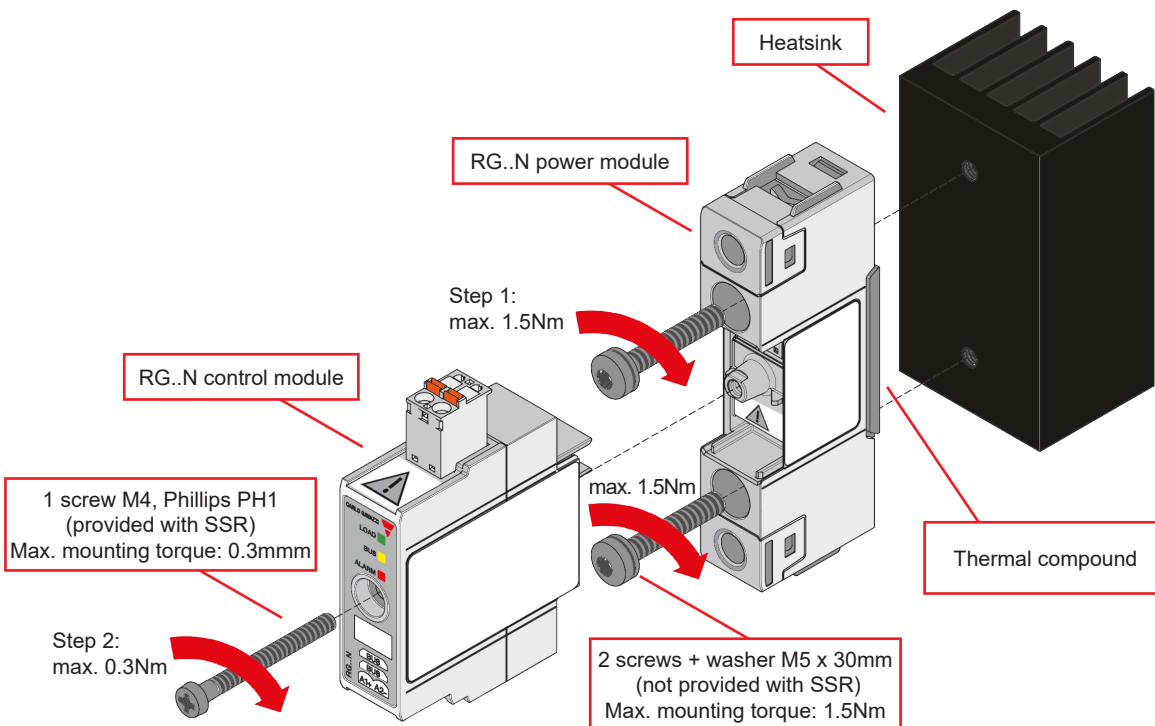

- Step 1: Mount RG..N power module to Heatsink
- Step 2: Mount RG..N control module on RG..N power module



Make sure that the sin code marked on the control unit matches the sin code of the power unit before mounting

Installation

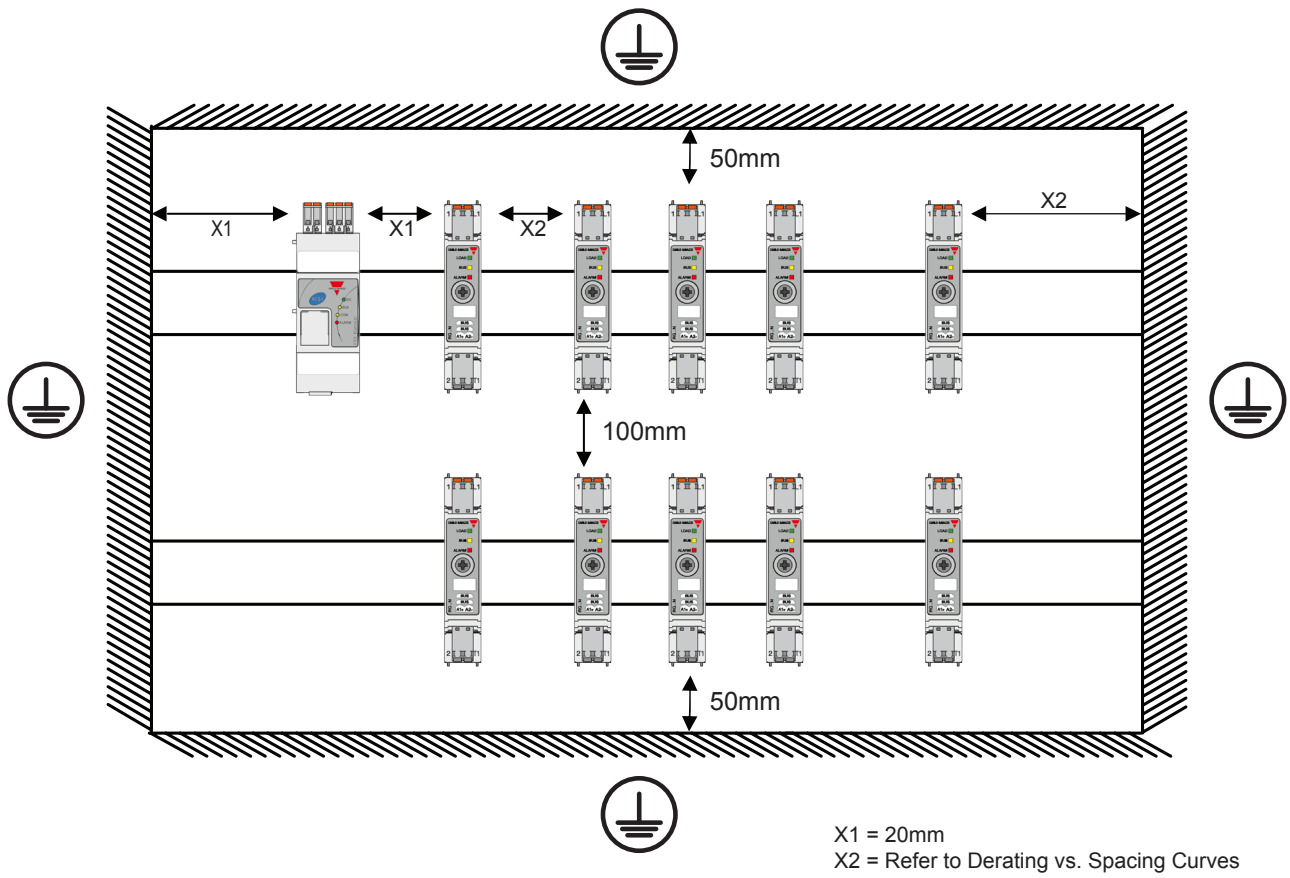

Connection specifications

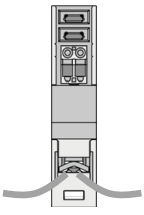
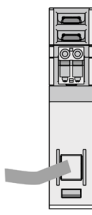
Power connection			
Terminal	1/L1, 2/T1		
Conductors	Use 75°C copper (Cu) conductors		
	RG..KEN	RG..GEN	
			
Stripping length	12 mm	11 mm	
Connection type	M4 screw with captivated washer	M5 screw with box clamp	
Rigid (solid & stranded) UL/CSA rated data	2x 2.5 – 6.0 mm ² 2x 14 – 10 AWG	1x 2.5 – 6.0 mm ² 1x 14 – 10 AWG	1x 2.5 – 25.0 mm ² 1x 14 – 3 AWG
Flexible with end sleeve	2x 1.0 – 2.5 mm ² 2x 2.5 – 4.0 mm ² 2x 18 – 14 AWG 2x 14 – 12 AWG	1x 1.0 – 4.0 mm ² 1x 18 – 12 AWG	1x 2.5 – 16.0 mm ² 1x 14 – 6 AWG
Flexible without end sleeve	2x 1.0 – 2.5 mm ² 2x 2.5 – 6.0 mm ² 2x 18 – 14 AWG 2x 14 – 10 AWG	1x 1.0 – 6.0 mm ² 1x 18 – 10 AWG	1x 4.0 – 25.0 mm ² 1x 12 – 3 AWG
Torque specifications	Posidrive bit 2 UL: 2.0 Nm (17.7 lb-in) IEC: 1.5 – 2.0 Nm (13.3 – 17.7 lb-in)	Posidrive bit 2 UL: 2.5 Nm (22 lb-in) IEC: 2.5 – 3.0 Nm (22 – 26.6 lb-in)	
Aperture for termination lug (fork or ring)	12.3 mm	n/a	
Protective Earth (PE) connection	M5, 1.5 Nm (13.3 lb-in) M5 PE screw is not provided with the solid state relay. PE connection is required when product is intended to be used in Class 1 applications according to EN/IEC 61140		

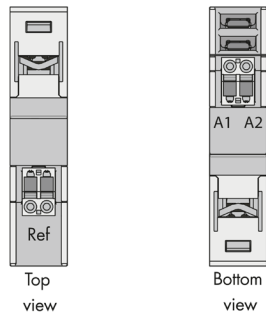
Control & Ref connection	
Terminals	Ref (x2 poles internally shorted on RG..N) A1+, A2-
	 <p>Top view</p> <p>Bottom view</p>
Conductors	Use 60/75°C copper (Cu) conductors
Stripping length	11 – 12 mm
Connection type	Spring plug, pitch 5.08 mm
Rigid (solid & stranded) UL/CSA rated data	0.2 – 2.5 mm ² , 26 – 12 AWG
Flexible with end sleeve	0.25 – 2.5 mm ²
Flexible without end sleeve	0.25 – 2.5 mm ²
Flexible with end sleeve using TWIN ferrules	0.5 – 1.0 mm ²
Ref internal short current handling capability	< 2 AAC

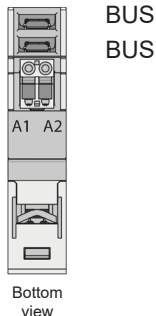
BUS connection	
Terminal	BUS (x2)
	 <p>BUS</p> <p>BUS</p> <p>A1 A2</p> <p>Bottom view</p>
Type	RCRGN-xxx (where xxx refers to the length in cm) 5-way terminated with micro USB connector Cable lengths available: 10cm RCRGN-010-2 75cm RCRGN-075-2 150cm RCRGN-150-2 350cm RCRGN-350-2 500cm RCRGN-500-2
Conductors	+24 V, GND, Data, Data, Auto- addressing line



RCRGN..

NRG internal BUS cable



Main features

- Cables available at various lengths to provide the internal BUS of the NRG system
- Cables terminated at both ends with a microUSB plug
- Connects the NRGC to the RG..N solid state relay and respective RG..N solid state relays

Description

The **RCRGN** cables are proprietary cables that must be used with the NRG system for the internal BUS. These cables connect the NRG controller to the RG..N solid state relays and respective RG..N solid state relays.

The RCRGN... are 5-way cables carrying the communication, supply and auto- addressing lines. By means of auto-addressing, the RG..Ns are assigned a unique ID based on the physical location and hence internal BUS wiring sequence when an auto- addressing command is sent to the RG..Ns.

Carlo Gavazzi compatible components

Description	Component code	Notes
NRG controller	NRGC	<ul style="list-style-type: none"> • NRGC: NRG controller with Modbus RTU communication. • NRGC-PN: NRG controller with PROFINET communication. • NRGC-EIP: NRG controller with EtherNet/IP communication. 1x RGN-TERMRES is included in the NRGC.. packaging. The RGN-TERMRES is to be mounted on the last RG..N on the bus chain.
Relays	RG..N	NRG solid state relays

Order code

RCRGN - - 2

Enter the code entering the corresponding option instead of

Code	Option	Description	Notes
R	-	Suitable for the NRG system	
C	-		
R	-		
G	-		
N	-		
<input type="checkbox"/>	010	10 cm cable length	packed x 4 pcs.
	075	75 cm cable length	packed x 1 pc.
	150	150 cm cable length	packed x 1 pc.
	350	350 cm cable length	packed x 1 pc.
	500	500 cm cable length	packed x 1 pc.
2	-	Terminated at the both ends with a microUSB connector	



COPYRIGHT ©2020
Content subject to change. Download the PDF: <http://gavazziautomation.com>