

RP1D

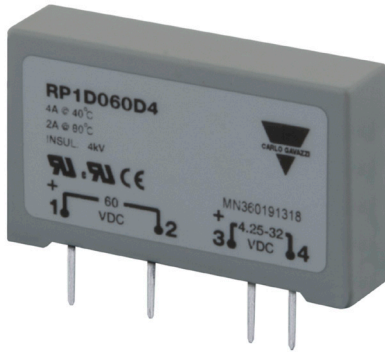

1-phase PCB mount DC switching solid state relays



Main features

- DC Solid State Relay for PCB mounting
- Rated operational current: Up to 8 ADC
- Rated operational voltage: Up to 350 VDC
- Surface mount technology
- Flexible encapsulation for extended life
- Control voltage: 4.25 to 32 VDC
- Isolation (Input to Output): 4000 VACrms

Description

The DC switching relay for PCB mounting is used in applications where there is a need for fast switching of small DC loads with a high input/output insulation of more than 4000 VACrms.

The DC switching relay always switches on and off in accordance with the applied control voltage.

Applications

These relays can be used to switch heaters, motors, valves or solenoids

Main functions

- DC switching
- Ratings up to 8 ADC / 60 VDC, 1 ADC / 350 VDC
- DC control voltage

Order code

 RP1D D

Enter the code entering the corresponding option instead of

Code	Option	Description	Comments
R	-	Solid State Relay (PCB) with DC switching	
P	-		
1	-		
D	-		
<input type="checkbox"/>	060	Rated voltage: 60 VDC	
	350	Rated voltage: 350 VDC	
D	-	Control voltage: 4.25-32 VDC	
<input type="checkbox"/>	1	Rated current: 1 ADC	
	4	Rated current: 4 ADC	
	8	Rated current: 8 ADC	
<input type="checkbox"/>	Mx	M1 = Mounting on DIN EN adaptor RPM1	Up to 250 V
		M2 = Mounting on DIN EN adaptor RPM2	Up to 600 V

Selection guide

Max. rated voltage	Control voltage	Rated operational current @ 40°C		
		1 ADC	4 ADC	8 ADC
60 VDC	4.25 - 32 VDC	-	RP1D060D4	RP1D060D8
350 VDC		RP1D350D1	-	-

Selection guide (mounted on DIN EN adaptor)

Max. rated voltage	Control voltage	Rated operational current @ 40°C		
		1 ADC	4 ADC	8 ADC
60 VDC	6.25 - 34 VDC	-	RP1D060D4M1	RP1D060D8M1
350 VDC		RP1D350D1M2	-	-

Carlo Gavazzi compatible components

Description	Component code	Notes
DIN rail adaptor	RPM1	DIN adaptor 250 V with LED
DIN rail adaptor	RPM1P	DIN adaptor 250 V with pins for removal of RP
DIN rail adaptor	RPM1PD	DIN adaptor 250 V with pins for removal of RP and LED
DIN rail adaptor	RPM2	DIN adaptor 600 V

Features

General data

Material	PBT, RAL7035
Potting compound	Flame-retardant flexible silicone rubber
Weight	Approx. 20 g
Isolation	Input to Output: 4000 VACrms

Dimensions

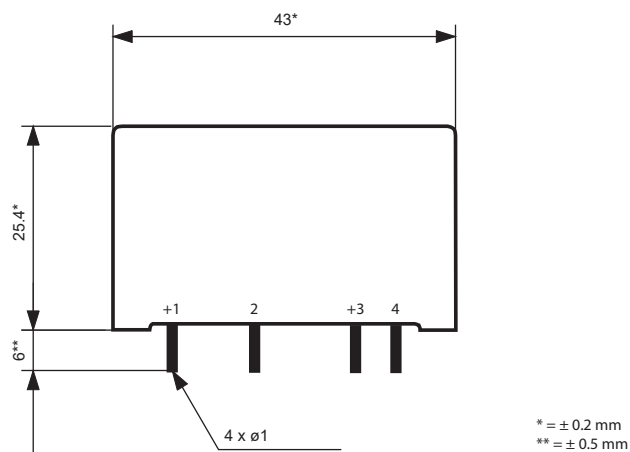
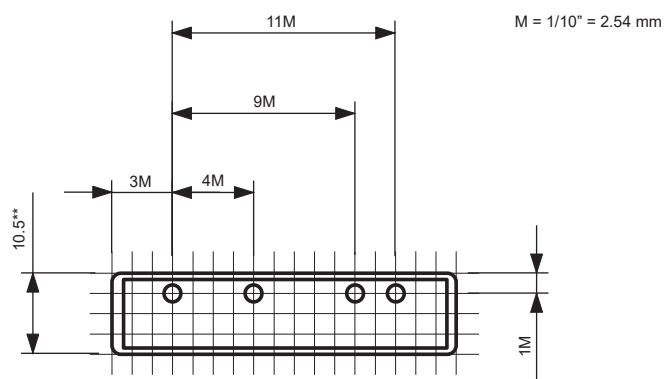

Performance

Mains supply

	RP1D060...	RP1D350...
Operational voltage range	1 - 60 VDC	1 - 350 VDC
Blocking voltage	60 VDC	350 VDC

Outputs

	RP1D350D1	RP1D060D4	RP1D060D8
Rated operational current @ Ta=40°C	DC1	1 ADC	8 ADC
	DC5	1 ADC	8 ADC
	DC13	1 ADC	8 ADC
Min. operational load current	1 mADC		
Rep. overload current t=1 s	20 ADC	15 ADC	60 ADC
Off-state leakage current @ rated voltage	< 0.01 mADC		
On-state voltage drop @ rated current	< 0.5 VDC	< 0.5 VDC	< 1.0 VDC

Inputs

Control voltage range (Uc)	4.25 - 32 VDC
Pick-up voltage @ Ta = 25°C	3.3 VDC
Drop-out voltage	1 VDC
Reverse voltage	32 VDC
Switching frequency	< 100 Hz
Response time pick-up @ V _{in} ≥ 5 VDC	< 100 μs
Response time drop-out @ V _{in} ≤ 24 VDC max.	< 250 μs
Input current	15 mA

▶ Derating curve

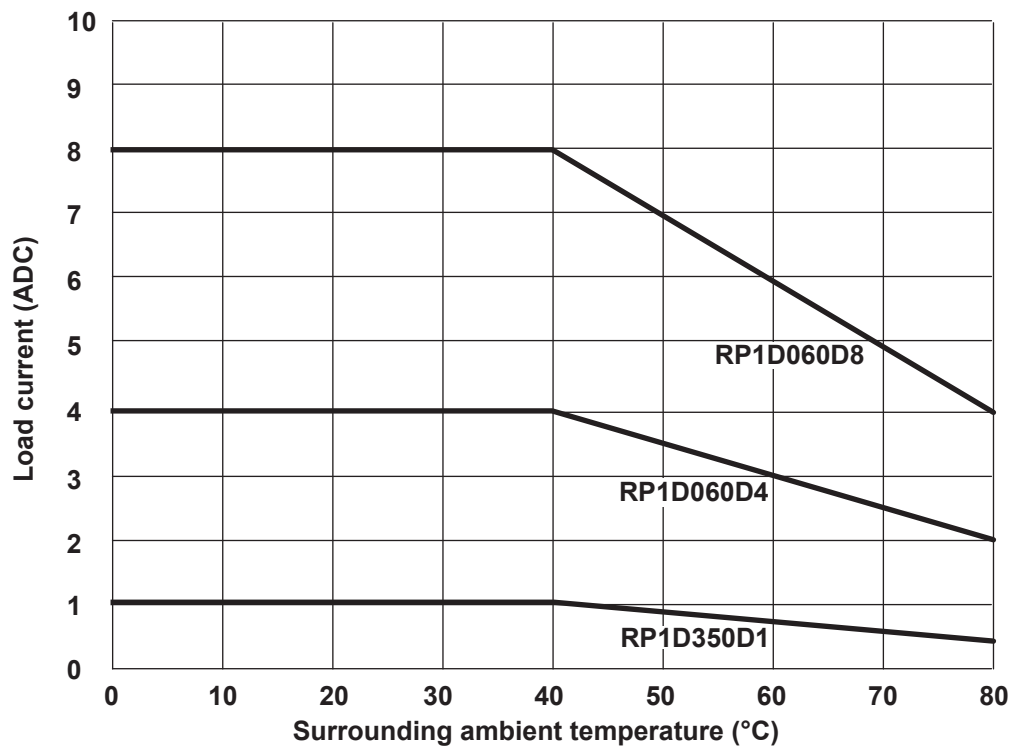

Compatibility and conformance

Standards compliance	LVD: EN 60947-1 EMCD: EN 60947-1 UL 508 C22.2 No. 14
Approvals	

Electromagnetic compatibility (EMC) - Immunity	
Electrostatic discharge (ESD)	EN/IEC 61000-4-2 8 kV air discharge, 4 kV contact (PC1)
Radiated radio frequency	EN/IEC 61000-4-3 10 V/m, from 80 MHz to 2700 MHz (PC1) ²
Electrical fast transient (burst)	EN/IEC 61000-4-4 Output: 2 kV, 5 kHz (PC2) Input: 1 kV, 5 kHz (PC2)
Conducted radio frequency	EN/IEC 61000-4-6 10V/m, from 0.15 to 80 MHz (PC1) ²
Electrical surge	EN/IEC 61000-4-5 Line to earth: 500 V (PC2) Line to line: 500 V (PC2)
Voltage dips, interrupts and variations	EN 61000-4-29 0, 30, 40, 60, 70, 80, 120% 1, 3, 10, 30, 100, 300, 1000ms (PC2)
Voltage interruptions	EN/IEC 61000-4-11 0% for 10 ms (PC2) 0% for 20 ms (PC2) 0% for 40 ms (PC2) 0% for 100 ms (PC2) 0% for 200 ms (PC2) 0% for 5000 ms (PC2)

Electromagnetic compatibility (EMC) - Emissions	
Radio interference field emission (radiated)	EN 55011 Class A ¹ : from 30 to 1000 MHz
Radio interference voltage emissions (conducted)	EN 55011 Class A ¹ : from 0.15 to 30 MHz

Environmental specifications

Operating temperature	-20° to +80°C (-4° to +176°F)
Storage temperature	-40° to +100°C (-40° to +212°F)
Pollution degree	2
EU RoHS compliant	Yes
China RoHS	

The declaration in this section is prepared in compliance with People’s Republic of China Electronic Industry Standard SJ/T11364-2014: Marking for the Restricted Use of Hazardous Substances in Electronic and Electrical Products.

Part Name	Toxic or Harardous Substances and Elements					
	Lead (Pb)	Mercury (Hg)	Cadmium (Cd)	Hexavalent Chromium (Cr(VI))	Polybrominated biphenyls (PBB)	Polybrominated diphenyl ethers (PBDE)
Power Unit Assembly	x	0	0	0	0	0

O: Indicates that said hazardous substance contained in homogeneous materials for this part are below the limit requirement of GB/T 26572.

X: Indicates that said hazardous substance contained in one of the homogeneous materials used for this part is above the limit requirement of GB/T 26572.

这份申明根据中华人民共和国电子工业标准 SJ/T11364-2014：标注在电子电气产品中限定使用的有害物质

零件名称	有毒或有害物质与元素					
	铅 (Pb)	汞 (Hg)	镉 (Cd)	六价铬 (Cr(VI))	多溴化联苯 (PBB)	多溴联苯醚 (PBDE)
功率单元	x	0	0	0	0	0

O:此零件所有材料中含有的该有害物低于GB/T 26572的限定。

X: 此零件某种材料中含有的该有害物高于GB/T 26572的限定。

Note:

1. A filter is required to meet the Class A limits of EN55011: A filter (capacitor or snubber) could be necessary from 60 / 350 VDC supply to chassis Ground. A filter (capacitor or snubber) could be necessary from 24 VDC input to chassis Ground.

Attention: This product has been designed for class A equipment. Use of the product in domestic environments may cause radio interference, in which case the user may be required to employ additional mitigation methods.

2. It is recommended that the control input lines are installed together (i.e. a 2 core cable) to ensure acceptable susceptibility to RF (Radio Frequency) is maintained. The manufacturer has set a maximum allowable deviation when under RF exposure of <1% FSD.

- Performance Criteria 1 (PC1): No degradation of performance or loss of function is allowed when the product is operated as intended.
- Performance Criteria 2 (PC2): During the test, degradation of performance or partial loss of function is allowed. However when the test is complete the product should return operating as intended by itself.
- Performance Criteria 3 (PC3): Temporary loss of function is allowed, provided the function can be restored by manual operation of the controls.

Functional diagram

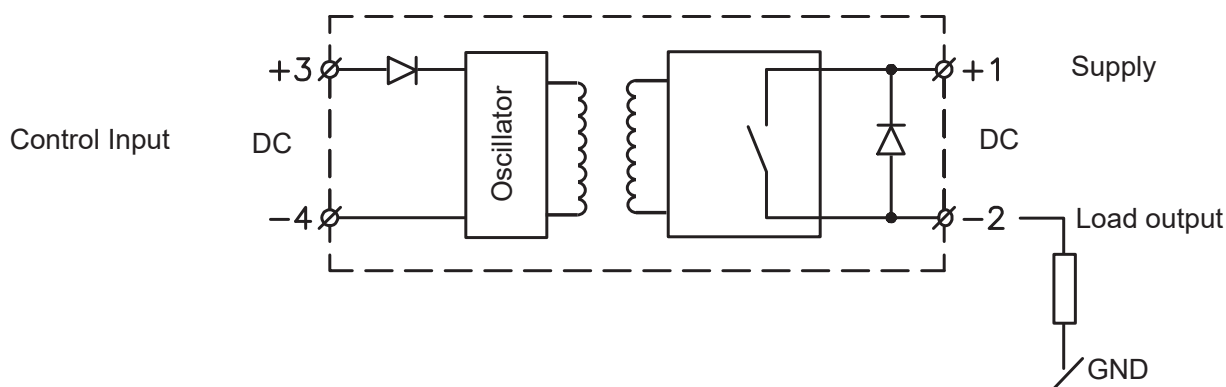

Connection specifications

Terminals	Copper alloy, tin-plated
Terminal soldering temperature	Max. 300°C for 5 seconds

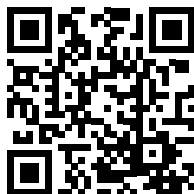

COPYRIGHT ©2019
Content subject to change. Download the PDF: www.productselection.net